

OWNER'S MANUAL

United States and Canada

Manufactured after January 1, 2009
© 2009 Lloyds Material Supply, Inc.

G3400Z Barbecue Island With Four Burner Grill, Double Side Burner, and Refrigerator



Cal Spas Home Resort™

www.calspas.com



WARNING

If the information in this manual is not followed exactly, a fire or explosion may result causing property damage, personal injury or loss of life.

Do not store or use gasoline or other flammable vapors and liquids in the vicinity of this or any other appliance.

Do not store an LP cylinder not connected for use in the vicinity of this or any other appliance. A fire resulting in serious injury or death may occur.

If you are installing a natural gas grill, you are responsible for ensuring that the natural gas line installed is safe to use. Lloyd's Material Supply (LMS) will not be held responsible for an improperly installed gas line.

Read all instructions before you operate your grill.

Notice to installer: These instructions must be conveyed to and remain with the customer.

Save these instructions!

California Proposition 65 Warning: Chemicals known to the State of California to cause cancer, birth defects or other reproductive harm are found in and/or created by the combustion of natural gas, propane, butane and other fuels. Always operate this unit as described in the owner's manual and in well ventilated areas.

Copyright 2008-2009 Lloyds Material Supply, Inc. All rights reserved. Duplication without written consent is strictly prohibited.

Cal Spas™ and Cal Flame™ are registered trademarks.

Due to continuous improvement programs, all models, operation, and/or specifications are subject to change without prior notice.

LTR20091046, Rev. B
6/25/09

Safety Instructions	1
Barbecue Island Set-Up	3
Installation Check-Off List	3
1. Prepare a Proper Foundation	3
2. Set Island Sections in Place	4
3. Install Gas Line for Side Burner	4
4. Install Electrical Service	4
5. Connect External LED Lighting	4
6. Install the Transformer in the Grill	5
7. Connect Gas to the Grill	6
LP Gas	7
Natural Gas	8
8. Place the Grill in the Cut-Out	8
9. Install the Side Burner	9
10. Refrigerator Installation	10
Using Your Grill	11
Grill Controls	11
Lighting the Grill	12
Basic Grill Operation	13
Cooking with the Rotisserie	13
Cooking with a Convection Grill	14
Light and Fan Switch	15
Cleaning and Maintenance	16
Stainless Steel Care and Cleaning	16
Cleaning the Interior of Your Grill	17
Covering Your Cart or Grill	18
Light Bulb Replacement	19
Appendix	20
Troubleshooting	20
Converting from LP to NG	22
Removing and Replacing Burners	24
Warranty Information	25

CONTACT INFORMATION

LMS Customer Service Department
1462 East Ninth Street
Pomona, CA 91766.

Toll Free: 1-800-CAL-SPAS
Fax: 1-909-629-3890

Safety Instructions

WARNING: Improper installation, adjustment, alteration, service or maintenance can cause injury or property damage. Read the installation, operating and maintenance instructions thoroughly before installing or servicing this equipment.

Placement and Location

- **Cal Flame™ grills are designed for outdoor use only.**
- Never locate this appliance in an enclosed room, under a sealed overhead structure, or in any type of enclosed area such as a garage, shed, or breezeway. Keep clear of trees and shrubs.
- Do not place this grill under or near windows or vents that can be opened into your home.
- Cal Flame™ grills are not intended for installation in or on recreational vehicles or boats.
- Maintain sufficient distance as to not overheat any overhead combustible material such as a patio cover.
- The area surrounding your new grill should be kept clean and free from flammable liquids and other combustible materials such as mops, rags or brooms, as well as solvents, cleaning fluids, and gasoline.
- Do not use the grill, grill cabinet, or area surrounding the grill as a storage area for flammable or plastic items. Do not store the liquid propane (LP) cylinder in the vicinity of this or any other appliance when it is not being used.

Set-Up

- Before installing built in grills in enclosures, copy all product information such as model number, serial number and type of grill (e.g. natural gas or LP) and store information in a safe place. This information is located on a plate located behind the grill and is visible when the hood is lowered or on the right side of the chassis. There is an area on the back cover of this manual where you can write down this information.
- We recommend that a licensed contractor install your Cal Flame™ grill. Installation must conform to local codes, or in the absence of local codes, with either the *National Fuel Gas Code, ANSI Z223.1 / NFPA54, Natural Gas and Propane Installation Code, CSA B149.1, or Propane Storage and Handling Code, B149.2*), as applicable.
- Your Cal Flame™ grill must be plugged into a permanent, grounded 110 VAC outlet with a dedicated 15 amp GFCI breaker in accordance with local codes or the *National Electrical Code, ANSI / NFPA 70, or the Canadian Electrical Code, CSA C22.1*.

- Do not use an extension cord to supply power to your Cal Flame™ grill. Such use may result in fire, electrical shock or other personal injury. Do not install a fuse in the neutral or ground circuit. A fuse in the neutral or ground circuit may result in an electrical shock hazard. Do not ground this appliance to a gas supply pipe or hot water pipe. Keep any electrical supply cords and the fuel supply hose away from any heated surfaces.
- To prevent fire and smoke damage, remove all packaging material before operating grill.
- Before you start cooking, clean the entire grill thoroughly with hot, soapy water. This is necessary to remove residual solvents, oil and grease used in the manufacturing process. The grates should also be thoroughly cleaned in the same manner.

Operation

- Do not use grill for other than intended use.
- In the event that a burner goes out, turn burner knobs to the full OFF position, fully open the grill hood and let it air out. Do not attempt to use the grill until the gas has had time to dissipate.
- Never use the grill if the drip pan is not properly installed. Drip pan should be pushed all the way to the rack located just under the grill. Fire or explosion can result from an improperly installed drip pan.
- Keep all electrical supply cords and the rotisserie motor cord away from the heated areas of the grill.
- Never use the grill or side burner in windy conditions. If used in a consistently windy area a windbreak will be required. Always adhere to the specified clearances listed in this manual.
- Never line the grill or side burners with aluminum foil.
- Do not install or operate your grill unit in such a manner that the cross ventilation openings are blocked. Fresh air must be able to pass through installed vents to safeguard against residual gas accumulation. Failure to allow proper ventilation may cause fire or explosion.
- When handling LP gas line and connectors, do not allow them to come in contact with any metal surfaces. Do not drop LP connectors.

Safety Instructions

- Do not use fuel such as charcoal briquettes in electric or gas grills
- Gas sources to the grill and side burners must be regulated. Do not operate grill or side burners if regulators have been removed, fire or explosion can occur.
- Never leave the grill and side burners unattended when in use. When using pots and pans, boil-overs will cause smoking and greasy boil-overs may ignite.
- Always position handles of utensils so they do not extend over adjacent work areas or cooking areas. This reduces the risk of burns, ignition of flammable materials, and spillage due to accidental contact with the utensils.
- Do not use water on grease fires. Never pick up a flaming pan. Turn the appliance off and smother the flaming pan with a tight-fitting lid, a cookie sheet or a flat tray. For flaming grease outside of the pan, smother it with baking soda or use a dry chemical or foam-type fire extinguisher.
- Never allow clothing, pot holders or other flammable materials come in contact with or be close to any grate, burner or hot surface until it has fully cooled. Never wear loose fitting or hanging garments while using your grill. Fabric may ignite and result in personal injury.
- When using the grill, do not touch the grill rack, burner grate, or immediate surroundings as these areas become extremely hot and can cause burns. Use handles or knobs.
- Only use dry pot holders and do not use a towel or other bulky cloth in place of pot holders. Moist or damp pot holders used on hot surfaces can cause burns.
- Do not heat any unopened glass or metal container of food on the grill. Pressure may build up and cause the container to burst, possibly resulting in serious personal injury or damage to the grill.
- Do not reach over your grill or any other surfaces when hot or in use.

Precautions Regarding Children

- Never leave children unattended in the area where the grill is being used. Close supervision of children is necessary when any appliance is use near children.
- Do not store items of interest to children around or below the grill.
- Never allow children to sit or stand on any part of the grill.

Barbecue Island Set-Up

You will need a second person to help you to avoid damaging the grill, the transformer, or your barbecue island.

Installation Check-Off List

Use this table to guide you with the installation of your barbecue island. Follow these steps in sequence.

1	Prepare a proper foundation with stub-ups.	Page 3
2	Set island sections in place.	Page 4
3	Install gas line for side burner.	Page 4
4	Install electrical service.	Page 4
5	Connect external LED lighting.	Page 4
6	Install the transformer in the grill.	Page 5
7	Connect gas to the grill.	Page 6
8	Place the grill in the cut-out.	Page 5 </td
9	Install the side burner.	Page 9
10	Place the refrigerator in the cut-out.	Page 10

1. Prepare a Proper Foundation

The G3400Z barbecue island arrives in three sections. After you have uncrated each section and removed all packing materials, place each section on a solid, level foundation. If you do not have a proper foundation, you will need to prepare one. See the pre-delivery guide for instructions and guidance.

Use the footprint drawing as a reference for barbecue island dimensions and service stub-ups.

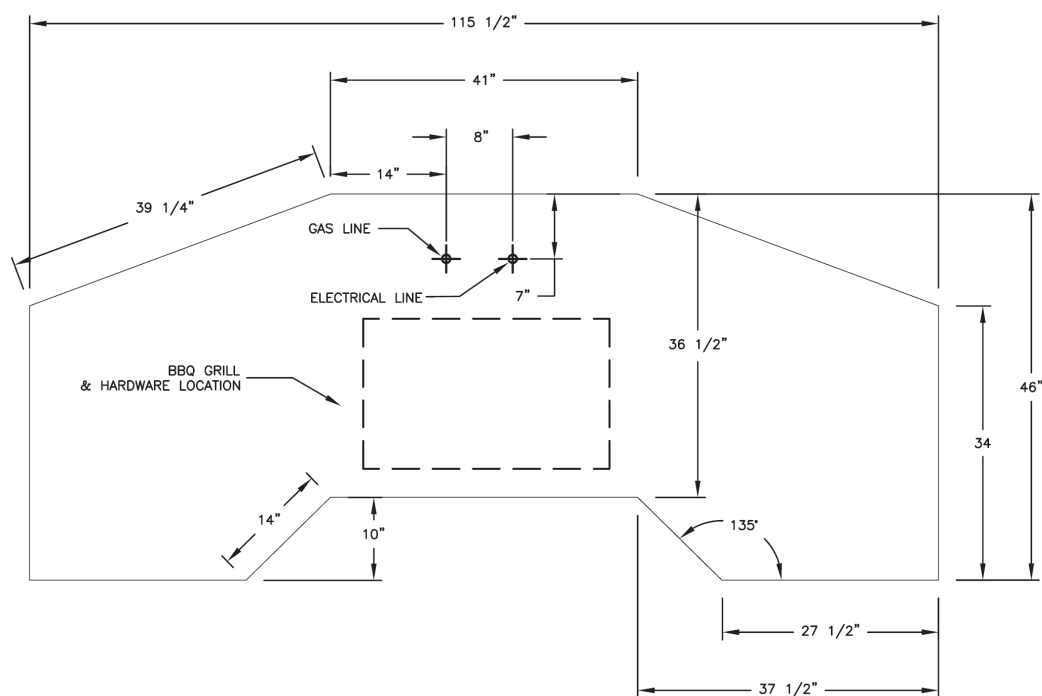

2. Set Island Sections in Place

Place the sections on the foundation and slide them together. As the sections meet, holes in the interior walls will come together where a gas line and wires for the LED lighting will pass through, as shown right.

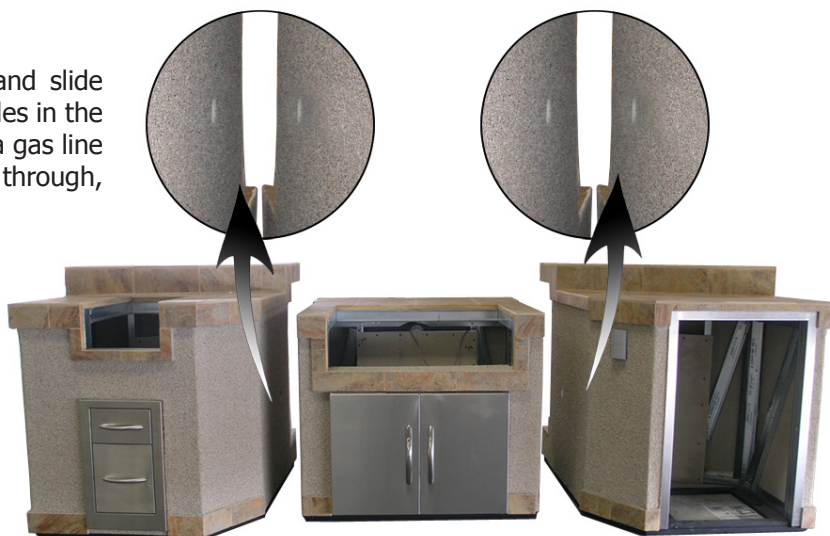

3. Install Gas Line for Side Burner

When the sections are in their final place, feed the flexible gas tubing through the holes between the left and center island sections.

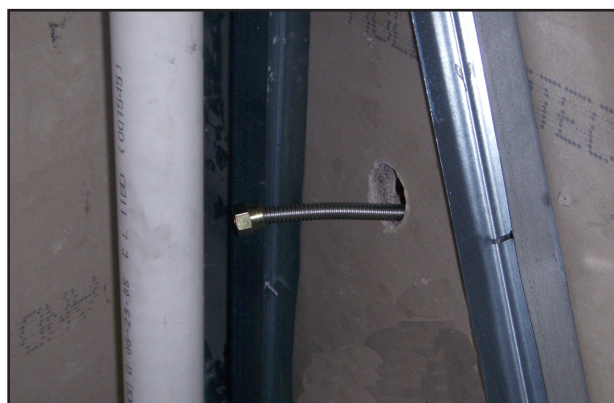

4. Install Electrical Service

You will need to hire a contractor to install a 110 VAC electrical service inside the right section behind the refrigerator. The island comes equipped with an outdoor GFI electrical outlet with a 12" romax lead.

The footprint drawing on the previous page shows the approximate location for the stub-up. See the pre-delivery guide for electrical specifications. The floor is not pre-drilled to accommodate the stub-up. Your contractor will have to do this.

5. Connect External LED Lighting

The external LED lighting is installed at the factory. You will need to feed the wires through the holes between the sections and connect the two ends.

The power source, located in the right island section, is permanently connected to the electrical outlet.



6. Install the Transformer in the Grill

The grill will require the transformer to be installed and plugged in before you can use it. The transformer provides power to the light and the convections fan. This needs to be done **before** the grill is placed in the island. When the transformer is attached to the grill chassis, use care in placing the grill in the island cutout to avoid hitting the transformer.

1. Remove the transformer and the metal screws from the plastic bag.
2. Place the grill on a sturdy surface and tilt it back to show the underside of the grill.
3. Using the metal screws, attach the transformer to the left side of the grill near the internal electrical connection. Attach the metal plate to the outside surface of the grill as shown in the figure below.
4. When you have firmly tightened the screws and nuts, connect the plug from the transformer to the grill. Screw on the stainless steel retainer.

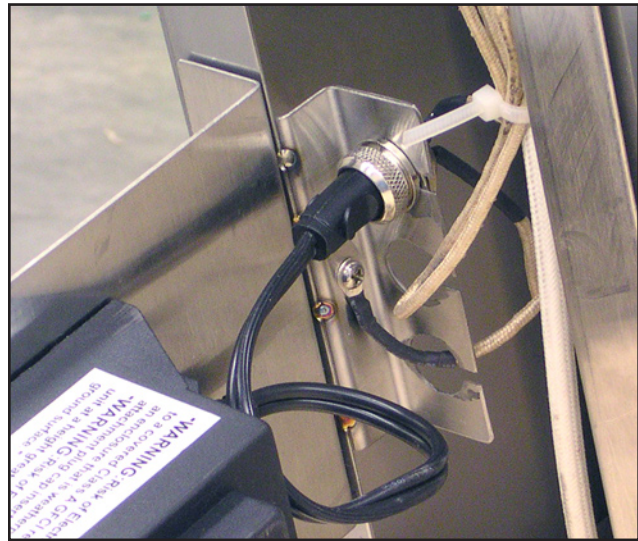
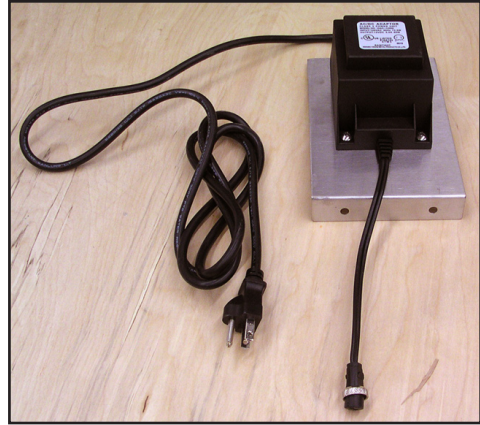

5. After you have placed the grill in the barbecue island, open the utility doors and feed the electrical cord for the transformer through the hole into the right side island section.
6. Plug the cord for the transformer into the electrical outlet inside the right side island section.

7. Connect Gas to the Grill

Gas Requirements and Connection

IMPORTANT: The Cal Flame grill is manufactured to operate on liquid propane (LP). However, it can be converted to operate on natural gas (NG) by an authorized service technician. Consult your Cal Flame dealer for information on converting your gas grill.

Owners must not convert their grills themselves. Attempting to convert the grill from LP to NG may result in serious injury and will void the warranty coverage.

If you do not have an updated filler valve on your existing propane tank, you will need to purchase one at your local hardware store. Without it you will not be able to attach your tank to your Cal Flame™ grill or refill the tank at your local propane refill station.

Leak Testing Procedure

Perform a leak test at least once a year whether the gas supply cylinder has been disconnected or not. In addition, whenever the gas cylinder is connected to the regulator or whenever any part of the gas system is disconnected or replaced, perform a leak test.

As a safety precaution, remember to always leak test your grill outdoors in a well-ventilated area. Never smoke or permit sources of ignition in the area while doing a leak test. Do not use a flame, such as a lighted match to test for leaks. Use a solution of soapy water.

1. Prepare a leak testing solution of soapy water by mixing in a spray bottle one part liquid soap to one part water.
2. Make sure all the control knobs are in the OFF position.
3. Turn on the gas.
 - a. On natural gas systems, turn the main feed valve to the grill.
 - b. On LP systems, turn the cylinder valve knob counter clockwise one turn to open.

4. Apply the leak-testing solution by spraying it on joints of the gas delivery system. Blowing bubbles in the soap solution indicates that a leak is present.
5. Stop a leak by tightening the loose joint or by replacing the faulty part with a replacement part recommended by the manufacturer. Do not attempt to repair the cylinder valve if it is damaged. The cylinder must be replaced.
6. Turn all control knobs back to the full OFF position.

If you are unable to stop a leak:

1. Turn all control knobs back to the full OFF position.
2. Shut off the gas supply to the grill and release pressure in the hose and manifold by pushing in and turning any of the control valves one quarter turn counter-clockwise.
3. On LP systems, remove the cylinder from the grill.
4. Call an authorized gas appliance service technician or an LP gas dealer.

Do not use the appliance until the leak is corrected.

LP Gas

Tank Requirements

For plumbed-in LP installation, use a convertible regulator and set it for LP gas.

Maximum line pressure for plumbed-in propane is 14" WC (3.5 kPa). Minimum line pressure for propane is 11" WC.

The grill unit must be used with the gas pressure regulator. The regulator will control and maintain a uniform gas pressure in the manifold. The burner orifices have been sized for the gas pressure delivered by the regulator.

WARNING: Attempting to operate the grill unit without the gas regulator installed could cause an explosion and possible death.

Cylinder Specification

Any LP gas supply cylinder used with this grill must be:

- Constructed and marked in accordance with the *Specifications for LP Gas Cylinders* of the U.S. Department of Transportation or the National Standard of Canada, *CAN/CSA-B339, Cylinders, Spheres and Tubes for Transportation of Dangerous Goods; and Commission*, as applicable.
- Approximately 12 inches in diameter and 18 inches high.

The maximum fuel capacity is 20 lbs. of propane, or 5 gallons. Full cylinder weight should be approximately 38 lbs. (43.7 lbs. nominal water capacity.) Never fill the cylinder beyond 80% full.

Place the dust cap on the cylinder valve outlet whenever the cylinder is not in use. Only install the type of dust cap on the cylinder valve outlet that is provided with the cylinder valve. Other types of caps or plugs may result in leakage of propane.

LP Gas Hook Up

An enclosure for an LP gas cylinder shall be vented by openings at the level of the cylinder valve and at floor level. The effectiveness of the openings for purposes of ventilation shall be determined with the LP gas supply cylinder in place. This shall be accomplished in one of the following manners:

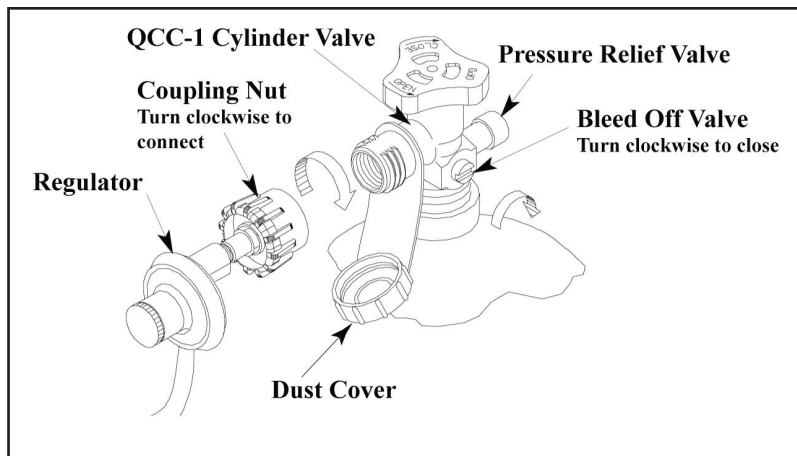

1. One side of the enclosure shall be completely open.
2. Enclosures that have four sides, complete with a top and bottom:
 - a. At least two ventilation openings at cylinder valve level shall be provided in the sidewall, equally sized, spaced at 180° (3.14 rad), and unobstructed. Each opening shall have a total free area of not less than one square inch per pound (7.1 cm²/kg) of stored fuel capacity, and not less than a total free area of 10 square inches (64.5 cm²).
 - b. Ventilation openings shall be provided at floor level and shall have a total free area of not less than one square inch per pound (7.1 cm²/kg) of stored fuel capacity and not less than a total free area of 10 square inches (64.5cm²). If ventilation openings at floor level are in a sidewall, there shall be at least two openings. The bottom of the openings shall be at floor level and the upper edge no more than 5 inches (127 mm) above the floor. The openings shall be equally sized, spaced at 180° (3.14 rad) and unobstructed.
 - c. Every opening shall have minimum dimensions so as to permit the entrance of a 1/8 inch (3.2 mm) diameter rod.

Transporting and Storing LP Gas

Transport only one cylinder at a time. Ensure the cylinder is secured in an upright position with the control valve turned off and the dust cap in place. Store cylinders outdoors and out of reach of children. Do not store cylinders in a building, garage, or any other enclosed area.

When your gas grill is not in use, turn off the gas at the supply cylinder.

Natural Gas Requirements

Always check the rating plate to make sure the gas supply you are hooking up to is the gas type the grill is manufactured for.

IMPORTANT: Never connect the grill to an unregulated gas supply.

The installation of this appliance must conform with local codes or, in the absence of local codes, to the national fuel gas code, ANSI Z223.1a-1998. Installation in Canada must be in accordance with the standard CAN/CGA-B149.2, Propane Installation Code.

A licensed contractor or local gas company representative must perform all natural gas connections.

Ensure that the service supplying the grill is fitted with a shut off valve conveniently positioned near the grill and giving ease of access.

The grill must be isolated from the gas supply piping system by closing its individual manual shutoff valve during any pressure testing of the gas supply piping system at test pressures equal to or less than 0.5 psi (3.5 kPa).

The grill and its individual shutoff valve must be disconnected from the gas supply piping system during any pressure testing of that system at test pressure in excess of 0.5 psi (3.5 kPa).

Your Cal Flame™ grill for use with natural gas comes equipped with its own regulator that **MUST NOT** be removed. If, this regulator needs to be replaced use only the type specified by Cal Flame™ for this appliance.

Connection

1. Remove the rear panel from the barbecue to gain access to the regulator and gas connection point.
2. Connect a suitable flex connector to the grill regulator.
3. Check the grill controls to ensure all control valves are in the full OFF position.
4. Turn on the main gas supply and check all connections for leaks using soapy water as described in the leak testing procedure section.

Warning: If you see bubbles in the soapy solution at any of the connections, turn off the gas supply and tighten the connection. If tightening the connection does not seal the leak, it may be necessary to replace the flex hose.

8. Place the Grill in the Cut-Out

Keep your fingers away from where the grill will be supported on counter. Your fingers could become trapped and serious injury could occur.

The grill should rest on the lip of the frame.

Check to make sure the grill is level and is supported around the entire outside edge. If the grill is not level or is unstable, use non-combustible shims under the outside lip to stabilize it.

Pay careful attention to the location of gas lines. Gas lines should be routed away from sources of heat and should make as few bends as possible.

Check to see if gas line connections will be accessible when grill is installed.

If gas line connections are not easily accessible when the grill is installed, support the grill above counter level and attach the gas lines to the grill. When the gas connections are made, slide the grill into the cut out.

If gas line connections are accessible when the grill is installed, slide the grill into the cut out and then attach the gas lines.

Be very careful not to kink gas lines when lowering the grill or side burner into the cut out.

9. Install the Side Burner

1. Assemble a 3/8" pipe nipple to the 3/8" pipe tee using Teflon tape or pipe sealant. Use only sealant that is approved for use on LP gas.
2. Install the pipe tee assembly to the grill intake pipe. Tighten assembly and align the branch opening of the tee with the hole of the cabinet.

Items Included with Barbecue

- 1) "T" adapter (3/8")
- 2) 2 each Hose 3/8" Fittings
- 3) Regulator/ Hose

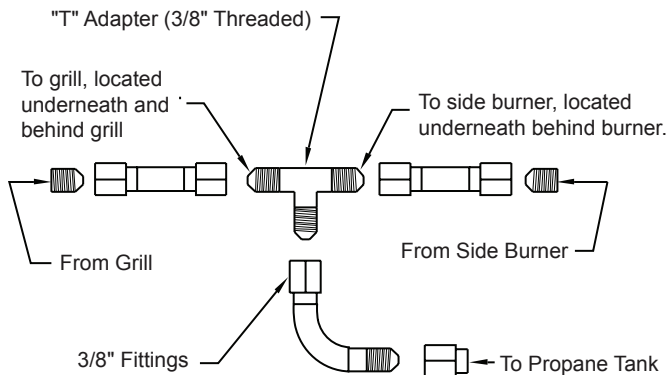

NOTE: You will need to use a gas rated sealer on gas connectors that are not flared.

3. Connect the flexible hose (male end) to the pipe tee.
4. Install and secure the side burner into the island by simply setting it in place.
5. Connect the female end of the flexible hose to the side burner intake pipe.
6. Connect gas supply to the grill.
7. Check for gas leaks using soap water solution.

- (A) Open barbecue door. Install hose with regulator on propane tank. Then connect other end to "T" adapter. Make sure to use gas rated tape seal when installing adapter to insure proper seal.

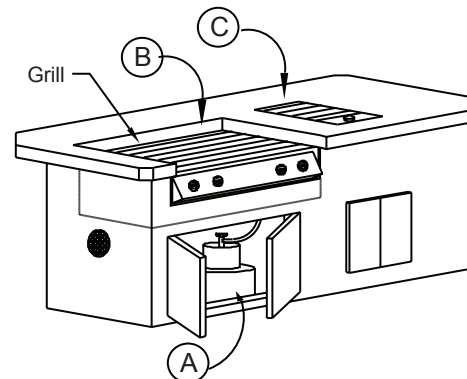

- (B) Then take other end of "T" adapter with hose attached and connect to end of male located underneath and at the back of the grill. (Use gas rated tape seal on all connections).
- (C) Connect the last open line to the side burner (Use gas rated tape seal on all connections)

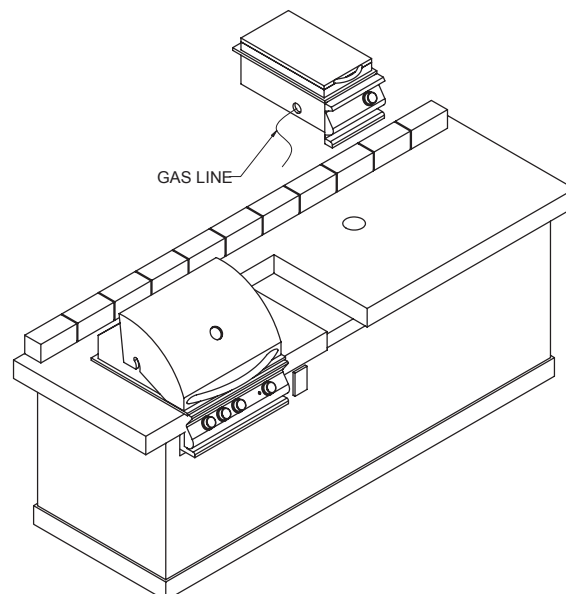

10. Refrigerator Installation

Remove the refrigerator from the box, remove all packing materials, and place it next to the cavity where it will be placed.

Untie the electrical cord and plug it into the 110 VAC electrical outlet located inside the right island section as shown below. Make sure your electrical contractor has completed installing the electrical service before you do this.

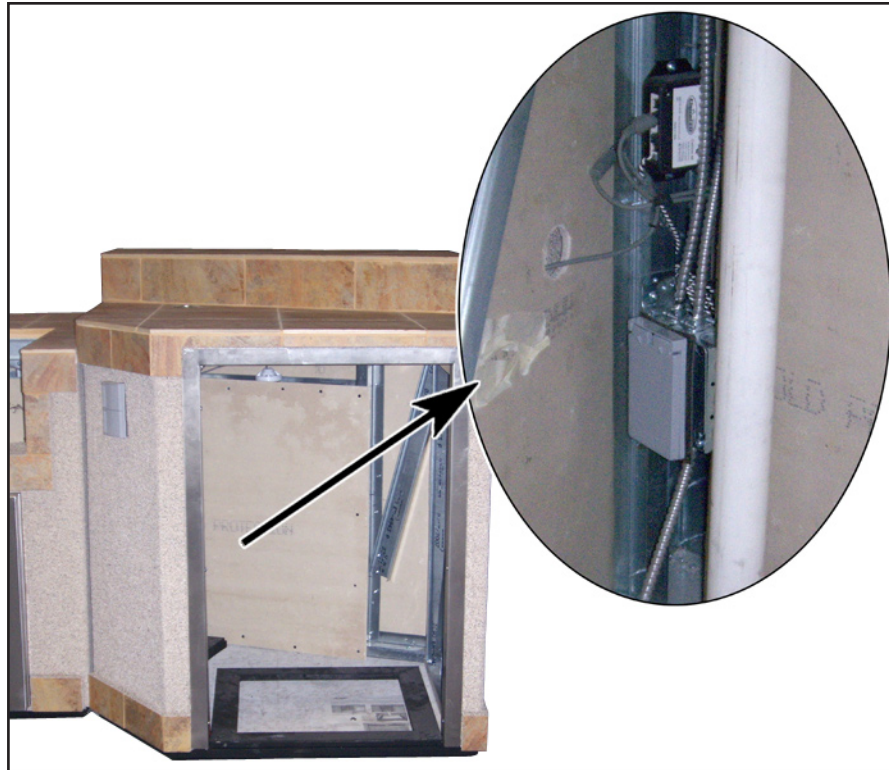

Using Your Grill

Read all instructions before you operate your grill.

We recommend you wash your entire grill with soap and water prior to lighting it for the first time. Oils are used during the manufacturing process and some residual oil may still be on the stainless steel parts of your grill. Washing will reduce the possibility of discoloration. We also recommend you keep your grill covered when not in use. This will minimize the amount of dust and dirt that accumulates on your grill and extend the life of your grill.

Remember to use your Cal Flame grill safely by following these reminders:

- It is dangerous to use barbecue grills and side burners in any manner other than for what it is designed for.
- Do not use charcoal in a gas grill or side burner or electric grill.
- Do not heat sealed containers such as cans or jars on grills or side burners. Explosion may result resulting in injury or death. Any sealed container, such as a pressure cooker, must have a properly operating pressure relieve valve to minimize explosion hazard.
- Never put combustible material such as paper, cloth, or flammable liquids on your grill at any time. Do not use grill, side shelves, cabinets, or any area around grill to store flammable materials.
- Never operate main burners and rear infrared convection burners at the same time. Excessive grill temperatures will result. Never allow your grill temperatures to exceed 500° F.

DANGER

What To Do If You Smell Gas

- Shut off gas to the appliance.
- Extinguish any open flame.
- Open lid.
- If odor continues, keep away from the appliance and immediately call your gas supplier or your fire department.

Grill Controls

The controls shown at right are for the Cal Flame™ drop-in grills. Familiarize yourself with these controls before using your Cal Flame™ barbecue.

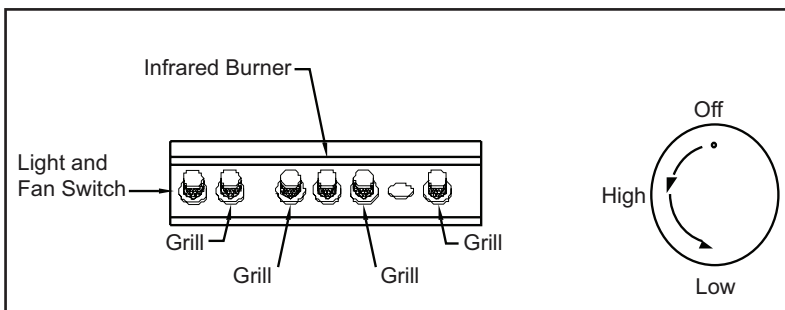

Warning

NEVER cover the entire cooking or grill surface with griddles or pans. Overheating will occur and burners will not perform properly when combustion heat is trapped below the cooking surface.

CAUTION: NEVER spray water on a hot gas unit. This may damage porcelain or cast iron components.

Lighting the Grill

Each time you light the grill, check the following:

- Inspect the hose before using the grill. If there is excessive abrasion or wear, or if the hose is cut, it must be replaced prior to using the grill. If you need a replacement hose, contact Cal Flame customer service.
- Ensure the area around the barbecue is clear of flammable substances such as gasoline, yard debris, wood, etc.
- Ensure there is no blockage of the airflow through the vent space located below the face of the unit.
- When using propane gas:
 - **Keep the special ventilation openings in the enclosure free and clear of debris.**
 - **If connected to a propane cylinder, carefully inspect the rubber hose attached to the regulator before each use.**
 - **Ensure the propane cylinder, regulator, and rubber hose are installed in a location not subject to heating above 125° F (51° C).**
- Ensure the burner flames burn evenly along both sides of each burner with a steady flame (mostly blue with yellow tipping). If burner flames are not normal, check the orifice and burner for insects or insect nests.
- Ensure the in-line gas valve or gas cylinder valve is always shut OFF when the barbecue is not in use.
- Do not operate the side burner with its cover closed or the back burner with its cover installed.

Electronically Lighting the Grill and Infrared Burners

1. Open the hood.
2. Keep your face as far away from the burners as possible.
3. Rapidly rotate the burner knob counter clockwise past the light position to HIGH. You will hear a loud click as the electronic lighter produces a spark.
4. Listen for the sound of the gas igniting. If the burner does not light on the first try, repeat immediately.
5. If the burner does not light after three attempts, turn the control knobs to the OFF position. Wait five minutes until the gas clears before attempting to light it again.
6. Repeat the procedure or try the manual lighting procedure below.
7. Upon successful lighting, repeat the process on the other burners you wish to light.
8. To shut off the burners, rotate the knob and turn to OFF. It is normal to hear a popping sound when the burners are turned off.

Manually Lighting the Grill and Infrared Burners

WARNING: Do not use standard matches or cigarette lighters to perform match lighting procedures. Serious burns can occur and lighters can explode.

1. Open the hood.
2. If you have just attempted to light the burner, allow five minutes for any accumulated gas to dissipate.
3. Slide out the drip tray from the grill.
4. Keep your face as far away from the burners as possible.
5. Light and insert a long stem match, holding it near the burner ports.
6. Push in and turn the control knob just past the LIGHT position to HIGH.
7. Listen for the sound of the gas igniting. If the burner does not light after five seconds, turn the control knobs to the OFF position. Wait five minutes until the gas clears before attempting to light it again.
8. If the burner does not light after several attempts see Troubleshooting Guide in the back of this manual.

Basic Grill Operation

Before lighting, make sure all burner controls are off. Do not attempt to light the burners if the smell of gas is present. Check the connection with a soap and water solution after attaching the hose. For LP units, make sure there is gas in the tank and it is sitting upright. For natural gas units, make sure the shut off valve is on.

1. Make sure the drip tray is in place.
2. Light the grill burners using the instructions on the previous page.

3. Turn the control knob to HIGH and preheat the grill for 15 minutes. Close the top cover during the appliance preheat period.
4. Place the food on the grill and cook to desired completion. Adjust heat setting if necessary. You may set the control knob to any position between HIGH and LOW.
5. Allow the grill to cool and clean the drip tray after each use.

Do not leave the grill unattended while cooking.

Cooking with the Rotisserie

The rotisserie burner is an infrared type, which provides intense searing radiant heat. It is designed to cook items from the back using infrared heat. The location of the burner allows the placement of a rotisserie-basting pan (NOT included) beneath the food to collect juices and drippings for basting and gravy.

Installation

1. Attach the two brackets to the sides of the grill, one on each side, using two screws as shown below.
2. Slide the rotis motor on one of the brackets as shown below. The rotis motor will work on either side of the grill.
3. Remove the metal cap protecting the outlet that provides power for the rotis motor. Plug in the motor cord and screw on the retainer nut to keep the plug in place.

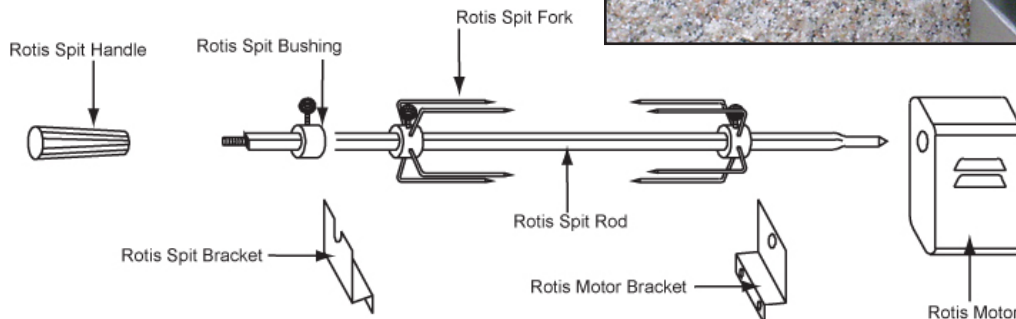
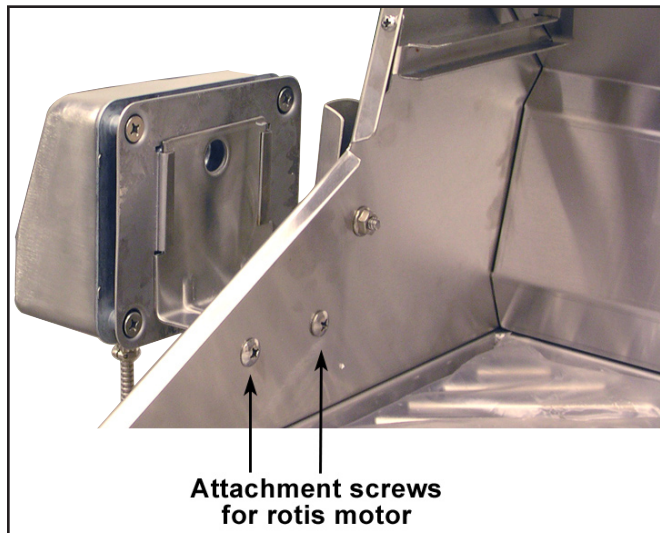

Cooking with the Rotisserie

1. To load the rotisserie rod, hold the handle firmly while sliding one of the fork assemblies (prongs facing away from the handle) onto the rod. Push the rod through the center of the food, then slide the other holder (prongs toward the food) onto the rod. Center the meat on the rod and push the fork assemblies firmly together. Tighten the thumbscrews. To secure any loose portions of your meat, use butcher string (never use nylon or plastic string). Place a basting pan under the food to collect the drippings.
2. To use the rotisserie, first mount the motor on the left side of the grill. Place securely onto support bracket.
3. The rod of the rotisserie system is assembled into the motor by placing the pointed end into the motor and resting the threaded end on the support at the side of the grill. Once the rod is pushed as far as possible into the motor, the grooved end of the rod should rest on the right side bracket.
4. If necessary, to offset unbalanced loads, slide the counter weight on to the rod. With the counter weight loose, allow the loaded rod to rotate and come to a stop. Now rotate the counter weight above the rod in a vertical position and tighten the thumbscrew. You can slide the counter weight away from or closer to the rotisserie rod as needed for balanced operation. Once lit, the rotisserie burner will reach cooking temperature in about one minute. The orange/red glow will even out in about five minutes.

Cooking with a Convection Grill

A convection grill has an internal fan that circulates heated air evenly throughout the grilling area when the hood is closed. Cooking in this way distributes heat more efficiently so you no longer have to be concerned with "hot spots" on the grill where food tends to burn. The fan switch is located at the far left of the front panel of the grill.

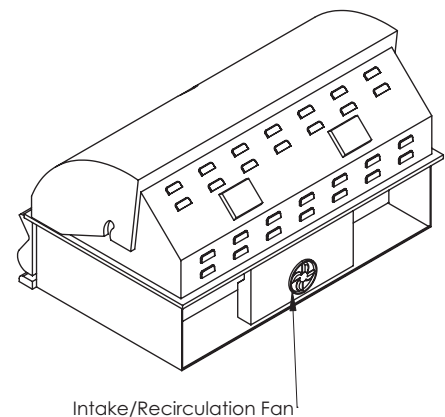
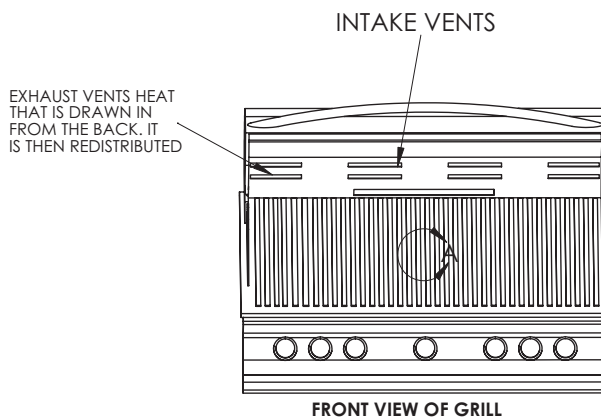

Light and Fan Switch

The ON / OFF switch controlling your halogen light and convection fan is located at the control panel on the front lower left side of the grill.



LED Lights

The switch for the LED lights is located in a covered utility box on the right side of the barbecue island. Switch it on to turn the exterior lights on.



Cleaning and Maintenance

To ensure safe and proper maintenance, we recommend you follow these directions carefully.

Clean internal parts of the grill regularly as determined by the amount of use and foods cooked. The entire grill should be cleaned at least once a year.

In addition, keep the area around your grill or cart clear and free from combustible materials, gasoline, and other flammable vapors and liquids. Do not obstruct the flow of combustion and ventilation air.

DISCONNECT ELECTRICAL SUPPLY BEFORE CLEANING ANY PART OF THE GRILL.

These instructions describe the best way to care for your stainless steel. They apply to grills, carts, and barbecue islands with stainless steel fixtures.

Although stainless steel grills will discolor and accumulate grime with regular use, they can keep their original shine with periodic cleaning. We strongly recommend using a surface protectant to prevent smudging and surface rust from accumulating.

The easiest way to clean the grill is immediately after cooking is completed. Doing so will extend the life of your grill, prevent grease fires, and present a pleasant appearance while you grill.

Stainless Steel Care and Cleaning

All exposed stainless steel surfaces require special attention if you want to keep them looking clean and bright. Following these simple instructions will help avoid scratching or damaging the finish and keep your stainless steel attractive.

Cleaning instructions for grill interiors, including racks and burners, are described after this section.

1. Clean

Thoroughly clean stains, food, and grime using a sponge or damp cloth with warm water and a mild dish soap. Use Fantastik or Formula 409 to remove heavier soil.

2. Rinse

Thoroughly rinse all surfaces and dry them completely with a clean towel. Do not allow stainless steel to air dry.

3. Polish

We strongly recommend that you apply a surface protectant to all exposed stainless steel surfaces.

Spray a small amount of WD-40 or Sheila Shine on a piece of paper towel and rub with the grain over the surface of the appliance. Using a clean terry cloth or

Cleaning Products and Materials

Avoid using these common cleaning products and materials – they will damage the surface of your stainless steel.

- CLR
- Lime-Away
- Oven cleaner
- Cleansers such as Ajax or Comet
- Ammonia
- Bleach
- Chlorine
- Steel wool pads
- Wire brushes
- Scrapers
- Pumice

We recommend these products for cleaning your stainless steel:

- Mild dish detergent such as Dawn
- Formula 409
- Fantastik
- Sheila Shine (exterior ONLY)
- WD-40 (exterior ONLY)

We have had best success with Sheila Shine, but WD-40 works very well too. Sheila Shine is available in some hardware stores; WD-40 is widely available.

Some people have reported that using baking soda, lemon oil, olive oil, vinegar, or club soda can be effective for cleaning light soil on all stainless steel surfaces.

Do not use steel wool or wire brushes to scrub your grill. For light soil, use a damp sponge or cloth. For heavier stains, use a Scotch-Brite scrubber or similar product.

paper towel, polish the appliance by rubbing with the grain until excess liquid is removed and the surface shines. It should not be oily to the touch, however some residue is acceptable.

Some people have reported that using lemon oil products such as Old English furniture polish is effective for polishing stainless steel and protecting the surface.

 **Caution** Do not use WD-40 or Sheila Shine near food or on food preparation surfaces as it is a health hazard. This includes the interior of the grill, grill racks, stainless steel sinks, the inside of cabinets, warming drawers, and ovens.

 **Fire Hazard** NEVER spray WD-40 or Sheila Shine near an open flame! These products are extremely flammable while in their aerosol forms.

Rust Removal

It is a common misconception that stainless steel does not rust. It does not stain, corrode, or rust as easily as ordinary steel (it *stains less*), but it is not stain-proof. If not properly protected and maintained, it can corrode, pit, and discolor.

 **Important** Because salt will accelerate rust and corrosion, grill or barbecue island owners who live near the beach need to be diligent in maintaining their stainless steel hardware. You need to clean and polish your stainless steel frequently, apply a protectant, and ensure water does not collect and puddle.

Periodically clean exterior stainless steel surfaces with WD-40 or Sheila Shine and wipe down with a dry cloth or paper towel until surface is free of rust. If there is significant rust or corrosion, use a Scotch-Brite scrubber.

Both of these products will act as a surface protectant and help resist smudges, stains, and rust.

 **Caution** Although nitric acid (also called aqua fortis) can be effective for rust removal, it is a highly corrosive chemical. Because of the potential for injury or damage to your stainless steel, we do not recommend using nitric acid.

Cleaning the Interior of Your Grill

1. Thoroughly clean stains, food, and grime using a sponge or damp cloth with warm water and a mild dish soap. Use Fantastik or Formula 409 to remove heavier soil.
2. Thoroughly rinse all surfaces and dry them completely with a clean towel. Do not allow water to accumulate and puddle on stainless steel. Water from various sources such as garden hoses contains iron which will give the appearance of rusting on stainless steel. If allowed to stand for long periods of time on stainless steel, it will cause pitting.
3. The racks, flame tamers, and flavor bars can all be removed for cleaning and are dishwasher safe.

Burners

Spiders and small insects occasionally inhabit or make nests in the burner tubes, obstructing the gas flow. Sometimes this results in a type of fire in and around the gas tubes called "flashback". To reduce the risk of flashback, this procedure should be followed at least once a month or when your grill has not been used for an extended period of time.

IMPORTANT: Prior to starting this procedure, turn OFF all of the gas control knobs, shut off the fuel supply, and disconnect the fuel line.

The burners can be removed by removing the keeper pins and lifting them out. The keeper pins are located under the grill toward the back. They are used to keep the burners in place during shipping and are not necessary to operate your grill. Remove burners from the grill by carefully lifting each burner up and away from the gas valve orifice.

Use a wire brush to clean the outer surface of each burner to remove food residue and dirt. Clean any clogged ports with a stiff wire such as an opened paper clip.

Inspect each burner for damage (cracks and holes). If any damage is found, replace the burner and discontinue grill usage.

Upon reinstallation, inspect the gas valve orifices for cleanliness and condition and the location of the igniters. When you replace the burners, you do not need to replace the keeper pins.

Cooking Grates

Use a solution equal parts detergent and hot water just as you would for any cooking equipment. A stiff wire brush or steel wool may also be helpful in removing grime and food deposits.



Note

Do not use a wire brush or stainless steel on any other part of your grill or any other stainless steel surface except the cooking grates or the griddle!

Drip Pan

The full width drip pan will collect grease from the main grill area. The pan should be cleaned after every use to avoid the possibility of a grease fire. Be sure to allow the drip pan to cool prior to cleaning. You may clean the drip pan with a solution of warm soapy water. Make sure to rinse thoroughly to avoid staining.

Charcoal Grills

To prevent burns or injury, make sure the grill is completely cool before cleaning. After initial usage, areas of the grill may discolor from the grill's heat.

There are various stainless steel cleaners available. Always use the mildest cleaning procedure first, and always scrub in the direction of the grain. Soapy water should be sufficient for most cleaning.

DO NOT use oven cleaners or abrasive cleaners on enameled surfaces. They may damage the finish, causing accelerated wear.

For your safety, make sure unit is cool and wood and charcoal embers completely extinguished before storing.

Remove the ashes as soon as possible after each use. Wait until the charcoal has cooled, slide out the drip pan and pour out the ashes. You can save the larger pieces of charcoal for the next time you cook. Use a garden hose to wash out accumulated grease and ashes. Allow the drip pan to dry before reinserting into the grill.

Griddle

To prevent burns or injury, make sure the griddle is completely cool before cleaning.

The griddle is made from non-magnetic, 304 grade stainless steel. There are various stainless steel cleaners available. Always use the mildest cleaning procedure first, and always scrub in the direction of the grain. Use soapy water for most cleaning. A non-abrasive scrubber may also be helpful in removing grime and food deposits. Steel wool may be used for especially difficult spots. Wipe all areas dry before storing.

Steam Cleaning Your Grill

Steam cleaning the interior of your grill is very effective and will not void your warranty. Portable hand-held steam cleaners are inexpensive and do not require chemicals. You can steam clean all parts of your Cal Flame grill, including the burners. When you are finished, make sure you wipe all surfaces down.

If you spray the burners, ignite them and let them burn for about 10 minutes to prevent any water from accumulating inside them.

Covering Your Cart or Grill

When not in use and after cooling, cover your cart or grill with our full length, zippered side canvas cover. (See your local Cal Flame dealer for details.) The cover will help protect your cart or grill from detrimental effects of weather and environmental pollutants. Never put a cover on a hot grill. Allow the grill to cool before covering.

Light Bulb Replacement

WARNING: Never attempt to replace a light bulb when the grill is in use. Serious burns will result.

WARNING: Never touch halogen bulbs with your bare fingers. Use a tissue or a small piece of paper to handle bulbs. Oils from your hands will damage halogen bulbs.

Light Removal

1. Open the grill hood and locate the glass light covers at the back of the grill.
2. Using a small screwdriver, gently pry the light cover away from the housing. *Be extremely careful prying off the light cover.* You may damage the light cover as a result.
3. Unscrew the two screws located at the side of the white ceramic light fixture.
4. Pull the burnt bulb out of the socket.

Light Replacement

1. Using a tissue or small piece of paper, carefully push a new bulb into the socket, making sure both wires on the bulb go into the light socket evenly.
2. Tighten the two screws on the side white ceramic light fixture.
3. Carefully replace the light cover by snapping it in place.



Appendix

Troubleshooting

Problem Smell of gas is present

Solution Check for loose connections in the gas line. Perform a leak test following the procedure described in this manual.

Problem Burner does not ignite

Solution Use the following procedure with the figure below.

Check the position of the sparker tip. It should be pointing forward towards the front of the burner.

- Make sure there is a blue spark at the electrode tip to the burner.
- Make sure the igniter wire is connected firmly to the valve ignition device and the electrode.
- Make sure the valve orifice is free of any debris, dust or grease.
- Make sure the valve orifice is aligned inside the front hole of the burner.
- If there is no spark at all, replace the electrode or igniter wire.

Note: Turn off the gas at the source while troubleshooting.

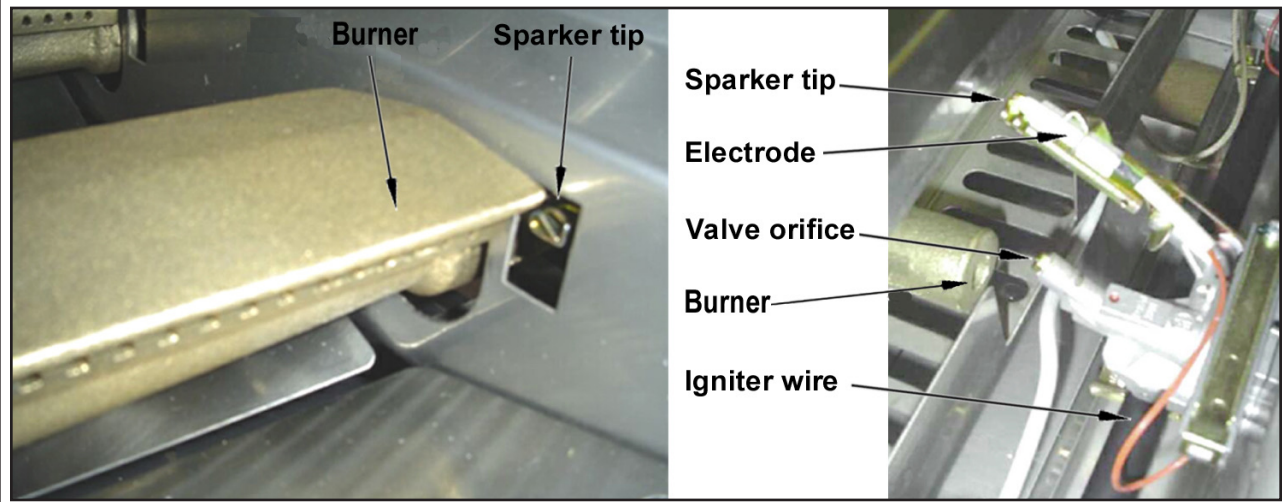

Problem Burner tube is misaligned over the orifice

Solution Reposition the burner tube so that it is properly seated over the orifice.

Problem Obstruction in the gas line

Solution Remove the fuel line from grill. (Do not smoke or perform any maintenance in the vicinity of an open flame.) Open the gas valve for one second to blow out any debris. Close off the gas valve and reconnect the fuel line securely.

Problem Yellow Flame
Solution Once the entire burner is operating, check the flame color to be sure that it is mostly blue. Some yellow at the tips may be present due to impurities in the fuel. If the flame is golden or yellow in color, the reason could be seasoning salts, oil film, or other foreign matter on the burner.

Problem Plugged orifice
Solution Unplug the orifice as follows:

- Remove cooking grills, flame tamer and grease tray.
- Remove burners from the bottom of the firebox by pulling the cotter pin from beneath the burner peg using a standard screwdriver or needle nose pliers.
- Carefully lift each burner up and away from the gas orifice.
- Remove the orifice from the control valve.
- Gently clear any obstruction with a fine wire.
- Reinstall the orifice, reinstall the burners over the orifices, and seat each burner peg into position hole at the bottom ledge of the firebox.
- Replace all cotter pins.
- Replace cooking components and grease collectors.

If an obstruction is suspected in the control valve, contact a qualified gas technician for assistance.

Problem Misalignment of Igniter on Burner
Solution

- Check for proper position of the electrode tip, which should be pointing forward towards the front of the burner and free of grease to allow proper sparking.
- The ignition wire should be connected firmly to the valve ignition device and electrode. Replace the ignition wire if it is frayed or cracked.
- With the gas supply closed and all control knobs set to the off position, check each position igniter individually for the presence of a spark at the electrode. Push each knob in fully and rotate it about 1/4 turn to the left (counter-clockwise) until you hear a loud click. The trigger hitting the strike block should produce a blue spark at the electrode tip. Return control knob to the off position before checking the next igniter.
- While the grill is still hot, wait for a minimum of five minutes before commencing re-ignition. (This allows accumulated gas fumes to clear.) If all checks / corrections have been made and the gas grill still fails to operate properly, contact qualified gas technician.

Problem Flashback
Solution When fire occurs in and around the burner tubes, immediately turn off gas at its source and turn all control knobs clockwise to the OFF position. Wait until the grill has cooled off and then clean the burner tubes and burners as described on page 20 of this manual.

Converting from LP to NG



WARNING! You must have an authorized service technician perform this procedure. If these instructions are not followed exactly, a fire or explosion may result causing property damage, personal injury or loss of life. Lloyd's Material Supply (LMS) will not be held responsible for an improperly converted gas grill.

All Cal Flame grills are manufactured as standard liquid propane (LP) grills and can be converted to burn natural gas (NG). There are two steps required to convert a grill from LP to NG.

You must perform both steps.

Step 1: Switching the regulator behind the grill

Step 2: Changing the burner orifices

The conversion kit provided with your grill may include **some or all** of the parts shown at right, depending on the size and model of your grill.

The kit contains orifices to convert main burners, rear infrared burners, and the large infrared burner. Your kit will have only the parts you need to convert your grill.

Before you begin, make certain the LP gas source has been disconnected from the grill. If you have a cart, you do not need to remove the grill from the cart.

To gain access to the NG regulator, tilt the grill forward.



1.9 mm orifices for main burners
(two to five pieces)



#50 orifice for large infrared burner
(one piece)



#54 orifices for dual infrared burners
(two pieces)

NOTE: A flared fitting is NOT included with your grill.

If you are attaching a flex hose to the regulator, you will need a fitting. The fitting requires a male flare on the input end with a 1/2" MPT on the output end. The flared male input end needs to be the size of your flex tubing. You can also connect the regulator directly to your NG gas service, which will not require a flared fitting.

Step 1: Switching the regulator behind the grill

The regulator in the image below has been removed from a grill to illustrate this procedure.

1. Remove the LP gas line.
2. Remove the cap fitting from the end of the NG gas regulator.
3. Place the cap fitting over the LP gas inlet.
4. Insert a male flared fitting (**not provided**) in the NG gas regulator.

You will need:

- 13mm open end wrench
- Male flared fitting (**not provided**)
- Pipe compound suitable for natural gas

Remove Cap Fitting

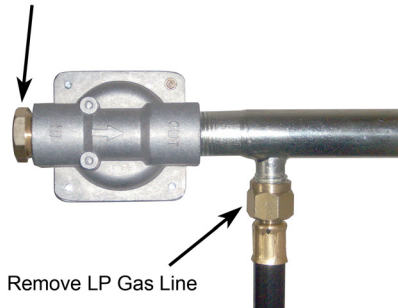

Remove LP Gas Line

Insert Flared Fitting in NG Regulator
(Flared Fitting Not Provided)

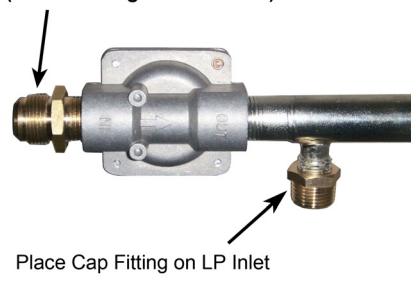

Place Cap Fitting on LP Inlet

Step 2: Changing the burner orifices

1. Replace the infrared burner orifices

- Using a 13mm wrench, remove the orifice for the infrared burner.
- Apply pipe compound to the fitting threads where you will place the new orifice.
- Screw on the correct orifice for your grill until it is finger tight.
- Tighten the orifice with the 13mm wrench.
- If you have dual infrared burners, repeat the previous steps for the second burner.
- Replace the back cover.

You will need:

- 13mm open end wrench
- One #50 orifice (for single infrared burner)
- Two #54 orifices (for dual infrared burners)
- Pipe compound suitable for natural gas

2. Replace the side burner orifices

- Remove the grate, burner cap and burner diffuser from the side burner.
- Using a 7mm wrench, remove the orifice for the burner.
- Apply a small amount of pipe compound to the orifice threads.
- Screw in the orifice until it is finger tight.
- Tighten the orifice with the 7mm wrench.
- If you have dual side burners, repeat the previous steps for the second burner.

You will need:

- 7mm wrench, socket, or nut driver
- One or two 1.75mm orifices (depending on your side burner)
- Pipe compound suitable for natural gas

3. Replace the main burner orifices

- Remove the grates, flame tamers, and drip tray from the grill.
- Remove the cotter pins from the end of the burners. The cotter pins are accessible from underneath the grill in the back in the accessory cabinet.
- Carefully remove the burner.
- Using a 6mm socket or nut driver, remove the orifice for the burner.
- Apply a small amount of pipe compound to the orifice threads.
- Screw in the orifice until it is finger tight.
- Tighten the orifice with the 6mm wrench.
- Repeat the above steps for the remaining burners.
- Replace the burners, cotter pins, flame tamers, drip tray, and grates.

You will need:

- 6mm socket or nut driver
- Two to five 1.9mm orifices (depending on your grill)
- Pipe compound suitable for natural gas

4. Mark the rating plate

After conversion has been completed, mark the rating plate as NG with an indelible marker.

Removing and Replacing Burners

Removing Stainless Steel Burner

1. Disconnect or shut off the gas line connect to the grill. Wait until the burners cool down.
2. Open the hood and remove the grate and flame tamer on top of the burner you want to replace.
3. Through the access door underneath the grill, find the round stud and locking pin that locks the burner you want to remove.
4. Carefully remove the locking pin with your fingers.
5. Raise the stud from the locking hole and move the burner forward carefully to release it from the ignition and gas supply valve.
6. Take the burner out of the grill and store it in a safe and dry place.

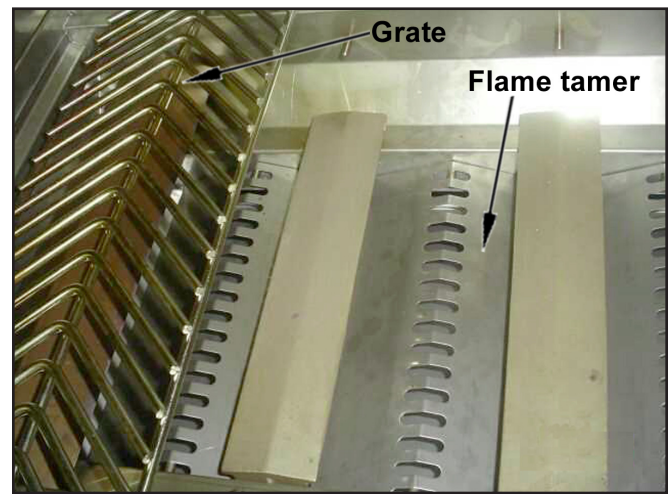
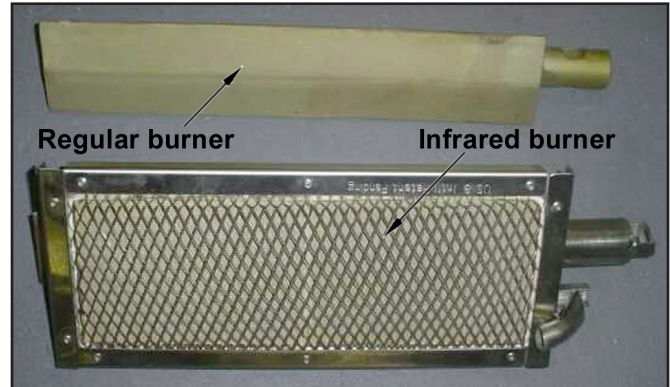

Removing Infrared Burner

1. Lower the hood and remove the access cover behind the grill.
2. Find the round stud and locking pin that locks the infrared burner you want to remove.
3. Carefully remove the locking pin with your fingers.
4. Raise the stud from the locking hole and move the burner outward carefully to release it from the ignition and gas supply valve.
5. Take the burner out of the grill and store it in a safe and dry place.

Locking pin on regular burner

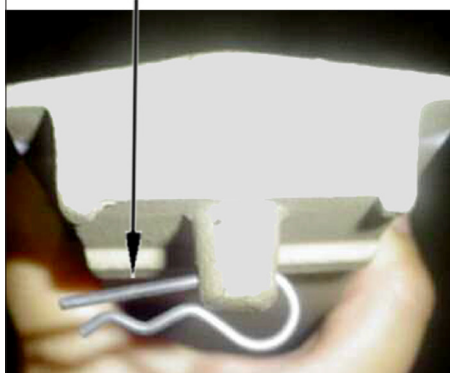

Locking pin on infrared burner



2009 WARRANTY

Lloyds Material Supply (LMS) offers the following limited warrants against defects in material and workmanship on Cal Flame barbecue products and components:

One Year Grill Equipment and Component Warranty

LMS warrants flame tamers, burners, grates, grill lid and body, and mountings against deterioration and corrosion.

One Year Barbecue Island Structure and Finish Warranty

LMS warrants the frame, galvanized steel, stucco, and granite at time of delivery.

LMS warrants the grill's structural frame, all non-stainless steel fasteners, temperature gauge, plastic items, stainless steel drawers, doors, warming rack, ignitors, tube stainless steel burners, gas valves, sear zone, and modules for a period of one year.

Extent of Warranty

This Cal Flame Warranty is only valid on Cal Flame models delivered in the United States or Canada and extends through the selling dealer to the original purchaser at the original site of installation. This warranty becomes valid at time of purchase and ends either by specified time-frame listed above or upon owner transfer or relocation.

Manufacturer Warranty

All Cal Flame models are manufactured with the highest quality appliances and are warranted to be free from defects in material and workmanship at time of delivery. The appliance warranty is extended through the manufacturer of the product. These items include, but are not limited to, refrigerators and accessories.

Warranty Performance

In the event of a malfunction or defect covered under the terms of this warranty, a factory authorized service agent of LMS will perform the necessary repairs. To obtain service, contact Cal Flame customer service. In the event the consumer is unable to obtain satisfactory customer service from the service agent, written notification must be given to the LMS Customer Relations Department within 10 days of the reported failure. There will be no charge for parts or labor on a covered item. However, the service agent may assess a reasonable travel or mileage charge per service call. If LMS determines that repair of a covered item is not feasible, LMS reserves the right to replace the defective merchandise with merchandise equal in value to the original purchase price. Warranty repair and / or replacement is the sole discretion of LMS and this warranty does not cover costs therein, including but not limited to: freight, removal, re-installation, etc. This warrant is non-transferable and may not be extended beyond the above mentioned time frames under any circumstances, by any of LMS's representatives.

Warranty Limitations

This limited warranty is void if the barbecue grill or island has been subject to negligence, alteration, misuse, dings, dents, scratches, or incorrect and / or prohibited applications, as specified in the Owner's Manual. Gas lines must be installed by a licensed plumber only or local gas company agent. Incorrect electrical installation by unlicensed electricians, service by non-LMS authorized representatives, acts of God and other cases beyond the control of LMS are not covered by this warranty. Please refer to the Owner's Manual for examples of exclusions and common acts invalidating this warranty. This limited warranty applies only to barbecue grills and islands used for personal, family, and outdoor household purposes and specifically excludes commercial barbecues. This warranty does not apply to labor charges on grills, replacement parts and hardware. This limitation is retroactive and applies to all grills and hardware manufactured from 2000 and hereafter. Examples of common acts invalidating this warranty include but are not limited to:

- Scratches caused by normal use.
- Damage caused by extreme weather conditions (hot, cold, etc.)
- Damage caused by dirt, sand, and/or water damage.
- Damage caused by continued operation of the barbecue with either known or unknown problems.
- Damage caused by direct sunlight.
- Damage caused as a result of failure to follow the operating instructions as defined in this Owner's Manual.



Warranty Exclusions

LMS warrants the barbecues from defects in material and workmanship for a period of one year from the original date of purchase.

Disclaimers

LMS shall not be liable for loss of use of the barbecue grills, islands or other incidental or consequential costs, expense or damages, which may include, but are not limited to, removal of permanent deck or other custom fixtures or the necessity for crane removal. Any implied warranty shall have duration equal of the applicable warranty stated above.

Legal Remedies

This limited warranty gives you specific legal rights. You may have other rights, which may vary from state to state.

Customer Service

If you need additional information or assistance, please contact the LMS Customer Relations Department at 1462 E. Ninth St., Pomona CA 91766 or call (800) 225-7727.

Contact Cal Flame customer service for a copy of the applicable warranty, details and any questions you may have regarding the warranty coverage on your barbecue.

Don't forget to register your new product at www.calspas.com.



Locating the product serial number

The serial number of your Cal Flame grill is located on the back and is visible when the hood is down (see picture above). The serial number of your barbecue island is located on a plate fastened to the floor inside the center section.

You will need these numbers to properly register your barbecue island and grill and activate coverage. Write this information in the space provided below.

Grill and island serial numbers: _____

Type of fuel (circle one): Liquid propane Natural gas

Date purchased: _____

Date installed: _____